

Portable Thermometers

Model TM20 thermometer with standard probe

Model TM25 thermometer with penetration probe

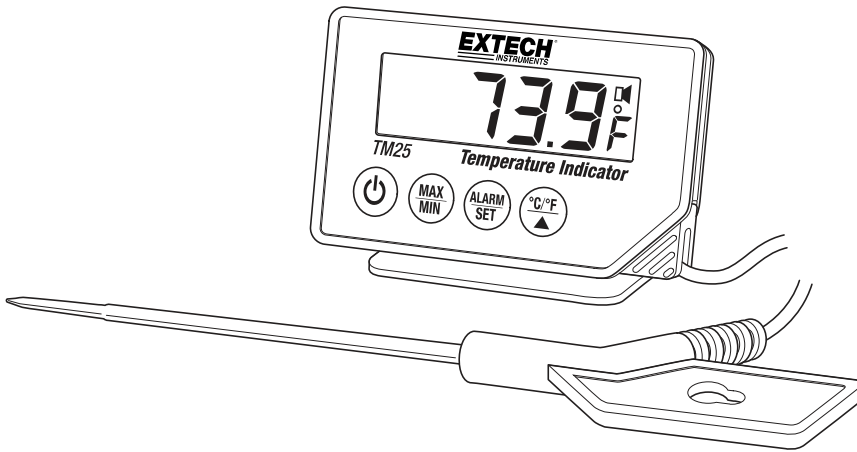
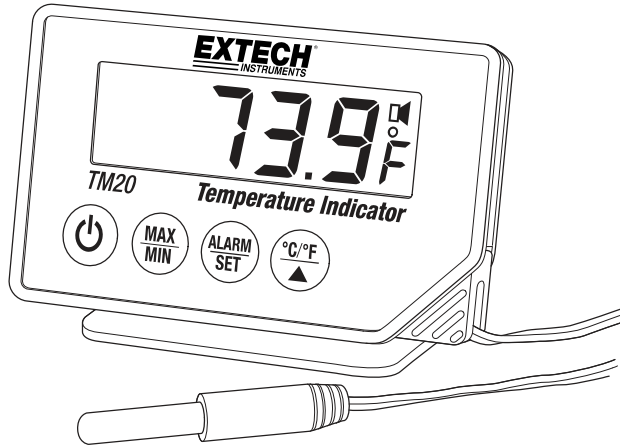

Introduction

Thank you for selecting this Extech Portable Thermometer for home use. This device is intended for use in measuring the temperature of air, liquid, paste, or semi-solid materials. The TM20 uses a standard temperature probe while the TM25 is equipped with a penetration probe for insertion into materials under test. This meter is shipped fully tested and calibrated and, with proper use, will provide years of reliable service. Please visit our website (www.extech.com) to check for the latest version of this User Guide, Product Updates, and Customer Support.

Safety

International Safety Symbols



This symbol, adjacent to another symbol or terminal, indicates the user must refer to the manual for further information.



This symbol, adjacent to a terminal, indicates that, under normal use, hazardous voltages may be present



Double insulation

General Safety

- Please read all safety and instructional information before using these products.
- These products are intended for home use only on air, liquid, pastes, and semi-solid materials.
- Unauthorized repairs, modifications, or other changes to the products are not supported.
- This product is not intended for use in medical practice.







Caution! Risk of Injury!

- Keep these products, their probes, and batteries out of the reach of children and pets
- Use extreme caution when handling the probes
- Batteries must not be placed in fire, short circuited, taken apart, or discharged. Risk of explosion!
- Batteries can be fatal if swallowed. Contact medical emergency personnel if batteries are swallowed.
- Batteries contain harmful acids. Low batteries should be changed as soon as possible to prevent damage caused by leaking batteries. 



Product Safety!

- Do not place these products near extreme temperatures, vibration, or shock 
- Only the probes are heat resistant to 392°F (200°C) for the TM25 probe and to 158°F (70°C) for the TM20 probe, not the meters themselves 
- Never hold a probe directly in or over fire 
- Do not immerse the meters in any liquid 



Description

Meter Description

1. Meter
2. LCD display
3. Power ON/OFF button
4. MAX/MIN button
5. ALARM/SET button
6. Temperature units/up arrow button
7. Meter stand/base
8. Sensor cabling
9. Sensor tips
10. Probe mounting bracket

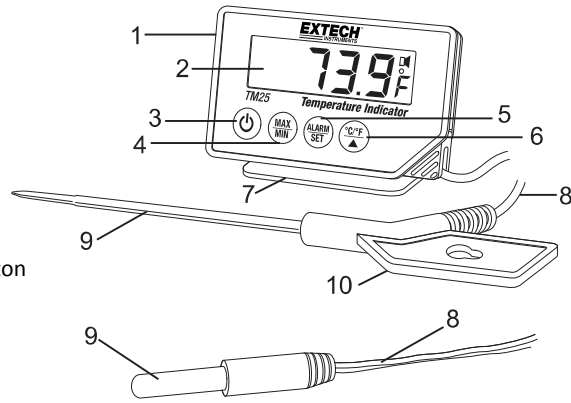

Note: Wall mount access hole and magnet on rear of instrument not pictured

Advanced Display Symbols

1. Low battery symbol
2. Alarm symbol
3. Flashing Alarm Alert
4. High Alarm symbol
5. Low Alarm symbol

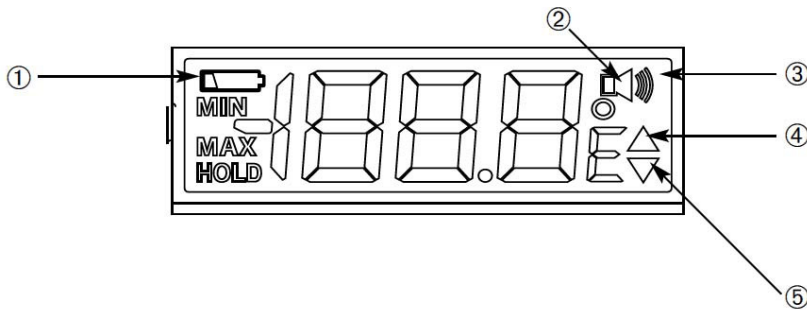

Operation

Display Protective Foil

The meter's display is shipped with a protective foil covering. Please remove carefully before use.

Powering the meter

Open the battery compartment by loosening the two screws located on the back of the meter (on either side of the magnet). Insert a new CR2032 3V lithium button battery and close the cover. If a battery is already installed, remove the insulation strip so that the battery can make proper circuit contact.

The instrument is now ready for use. Press the ON/OFF key once to power the meter. The meter's previous settings will be preserved.



Never dispose of used batteries or rechargeable batteries in household waste.

As consumers, users are legally required to take used batteries to appropriate collection sites, the retail store where the batteries were purchased, or wherever batteries are sold.

Disposal: Do not dispose of this instrument in household waste. The user is obligated to take end-of-life devices to a designated collection point for the disposal of electrical and electronic equipment.

Other Battery Safety Reminders

- Never dispose of batteries in a fire. Batteries may explode or leak.
- Never mix battery types. Always install new batteries of the same type.

Selecting °C/°F units of measure

Press the °C/°F key to select the desired temperature unit of measure.

MAX-MIN and HOLD Function

To freeze (hold) the displayed reading, press the MAX/MIN key. The current reading will be held on the display and the HOLD display icon will be visible. Press MAX/MIN again to view the Maximum reading captured since the last reset; the MAX indicator will be visible along with the MAX reading. Press MAX-MIN again to view the Minimum (MIN) temperature reading; the MIN icon will be visible along with the lowest reading captured since the last reset. To reset the MAX and MIN values press and hold the MAX-MIN button for 3 seconds while the MAX or MIN icon is visible. To return to normal operation press the MAX/MIN key again; the HOLD-MIN-MAX indicators should now be off.

Temperature Alarms

Set high/low alarm limits and the meter will audibly and visually alert the user if either limit is exceeded. To set the alarm values, follow these steps:

1. Press the ALARM/SET button once from the normal operating mode; the upper limit value and its symbol (up arrow) will flash.
2. Set the temperature limit by pressing the ▲ button (press and hold for fast scrolling).
3. Now use the MAX/MIN button to activate/deactivate the alarm (alarm symbol will appear in the upper right hand corner of the LCD when activated).
4. Verify the setting by pressing ALARM/SET.
5. Perform the same steps for the low alarm limit.

After setting the alarms, the upper and lower limit symbols (▲▼) will be displayed on the LCD indicating that an upper and a lower alert value has been set. If the measured temperature exceeds either limit, the alarm beeper will sound for 1 minute. The alarm beeper icon and the corresponding arrow will flash. Pressing any button will switch off the alarm.

When the temperature returns to the desired range the audible alarm will stop sounding. The arrow will remain flashing however to show that the temperature was higher or lower than a set value at least once in the past. Press the ▲ button to switch OFF the flashing arrow.

Specifications

Display	Multi-function LCD
Measurement range	TM20: -40 to 70°C (-40 to 158°F) TM25: -40 to 200°C (-40 to 392°F)
Resolution	0.1°C/°F
Accuracy	0.5°C: 0° to 24°C 1.0°C: -20° to -1°C and 25° to 49°C 2.0°C: -40° to -21°C and 50° to 200 °C 0.9°F: 32° to 75°F 1.8°F: -4° to 31°F and 76° to 120°F 3.6°F: -40° to -5°F and 121° to 392°F
Protection safety rating	IP 65 rating on meter and sensors
Low battery indication	Battery symbol appears on the LCD
Power supply	CR2032 3V button battery
Meter Dimensions	86(L) x 57(H) x 30(D) mm / 3.4(L) x 2.2(H) x 1.2(D)"
Cable length	TM20 cable: 209m (9.6 ft.) TM25 cable: 1.5m (5 ft.)

Copyright © 2013 FLIR Systems, Inc.

All rights reserved including the right of reproduction in whole or in part in any form

www.extech.com