

**Vibration Meter  
Model VB450**

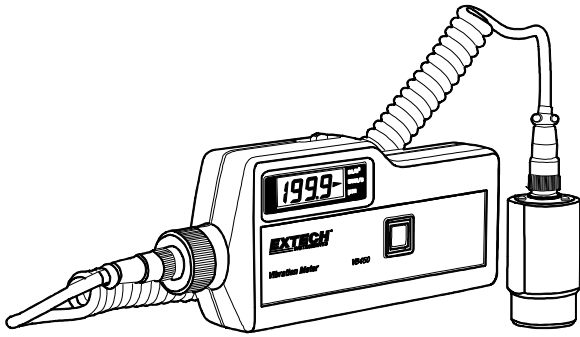

## ***Introduction***

---

Thank you for selecting the Extech Instruments Model VB450.

The VB450 is a portable vibration meter consisting of an acceleration sensor and a digital measurement display circuit. It can be used to measure vibration displacement, speed (or intensity) and acceleration of mechanical equipment. Equipment such as fans, pumps, compressors, motors, etc. can be tested.

This device is shipped fully tested and calibrated and, with proper use, will provide years of reliable service. Please visit our website ([www.extech.com](http://www.extech.com)) to check for the latest version of this User Guide, Product Updates, Product Registration, and Customer Support.

## Safety Notes

---

**Warning:** Use extreme care when using this vibration meter to test mechanical devices. Damage to meter and injury to persons can occur if this meter is used in a manner not specified in this User Guide or if nominal, preparatory safety measures are not taken. Please refer to, and follow, the safety directives below.

- Do not take measurements on devices where the range is known to be, or expected to be, outside the specified measurement range of this device.
- Do not use this instrument if its housing appears cracked, chipped, or otherwise damaged.
- Do not use this instrument if the sensor or its cable appears damaged or compromised in any way.
- Replace the battery as soon as the low battery symbol appears on the meter display.
- Remove the battery if the device is to be stored for > 60 days.
- Never dispose of batteries in a fire. Batteries may explode or leak.
- Do not attempt to charge the 9V battery. The supplied 9V battery is not rechargeable. This meter was not designed to use rechargeable batteries.
- If the meter operates abnormally, stop testing and have the unit serviced before further use.
- Never use the meter in a wet environment or in an atmosphere of combustible or explosive gas.
- Do not open the meter housing; there are no user-serviceable parts. Contact Extech Instruments directly or contact point-of-sale personnel for service inquiries.
- Protect the meter's LCD from shock or vibration; allow only the magnet and sensor to touch the devices under test.

## Meter Description

---

1. LCD Display
2. Three-position switch (selects measurement units)
3. Sensor and magnet
4. Lanyard
5. Power and Data Hold button
6. Service access nut (do not loosen; for service use only)
7. Sensor secure nut (turn counter-clockwise to loosen)

Battery Compartment on rear of meter

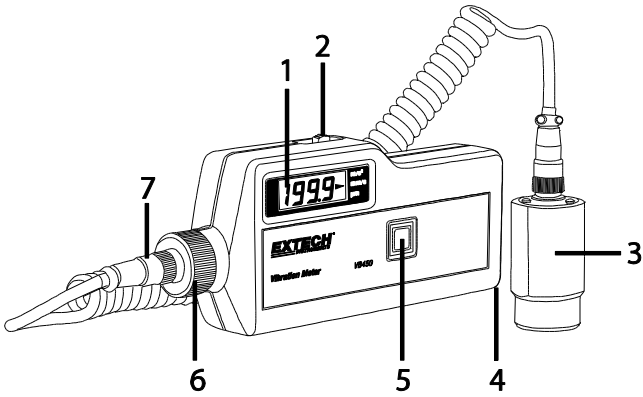

## Operation

---

### Battery Installation and Replacement

Remove the rear battery compartment door by sliding in the direction of the arrow. Install or replace 9V battery (observe polarity) and replace the cover.

During operation, if the  symbol appears in the display the battery needs to be replaced.



Never dispose of used batteries or rechargeable batteries in household waste.

As consumers, users are legally required to take used batteries to appropriate collection sites, the retail store where the batteries were purchased, or wherever batteries are sold.

**Disposal:** Do not dispose of this instrument in household waste. The user is obligated to take end-of-life devices to a designated collection point for the disposal of electrical and electronic equipment.

### Selecting units of measure

Press and hold the power button. The display will illuminate and an arrow will indicate the units selected. Slide the function switch on the top of the meter to select the units desired.

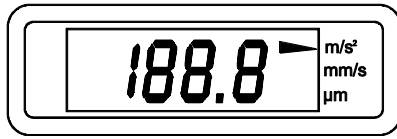

m/s <sup>2</sup>	Acceleration	Meters per second squared	PEAK
mm/s	Velocity	Millimeters per second squared	RMS
 µm	Displacement	micrometers	Peak to Peak

### Measurements



Attach the sensor to the device to be measured with the magnet or hold the sensor for nonferrous materials. Press and hold the power button to display the results. Release the power button to freeze the results in the display. After 60 seconds the meter will automatically shut off.

## Specifications

### General Specifications

Display	3 ½ digit LCD (0~1999)
Sensor	Accelerometer (magnetic base)
Cable Length	0.2m (7.9") coiled cable
Low battery indication	 symbol
Power supply	9V Battery
Battery life	Approx. 20 hours (alkaline)
Operating conditions	0 to 40°C (32 to 104°F) <90% RH
Storage conditions	0 to 40°C (32 to 104°F) <80% RH
Dimensions	185 x 68 x 30mm (7.3 x 2.7 x 1.2")
Weight	300 g (10.6 oz.) including battery
Safety Standards	GB 4793, 1-2007 For indoor use only

### Range and Accuracy

Function	Acceleration (Peak)	Velocity (RMS)	Displacement (Peak to Peak)
Range	0.1 to 199.9m/s <sup>2</sup>	0.1 to 199.9mm/s	1 to 199.9 
Frequency Response	10 to 1500Hz	10 to 1500Hz	10 to 500Hz
Accuracy	0 to 2.0m/s <sup>2</sup> ±(10%+ 1 digit) >2.0m/s <sup>2</sup> ±(5%+ 1 digit)	0 to 2.0m/s ±(10%+ 1d) >2.0m/s ±(5%+ 1d)	0  2.0µm ±(10%+ 1 digit) >2µm ±(5%+ 1 digit)

Copyright © 2015 FLIR Systems, Inc.

All rights reserved including the right of reproduction in whole or in part in any form

ISO-9001 Certified

[www.extech.com](http://www.extech.com)